



STIL
NOVO
GAS SYSTEM

outdoors

2015



gas system

l'emozione della fiamma avvolgente, tecnologia innovativa Italkero!

the emotion of an enchanting flame, innovative Italkero technology!

“GAS SYSTEM”, un’idea esclusiva Italkero, è l’innovazione tecnologica a gas nel mondo dei camini che offre risultati eccellenti.

Puoi godere la bellezza della fiamma accendendo il focolare con un telecomando.

L’opzione della legna “particolare” ti permetterà di avere lo stesso effetto di un camino tradizionale ma con un grande vantaggio: NON DOVRAI MAI CAMBIARLA!

“Gas system” is an exclusive Italkero idea, it’s a technological innovation for the gas fireplace world that offers excellent results.

You can enjoy the beauty of the flame simply by turning on the fire with a remote control.

Our unique ceramic wood assures the same effect of a traditional fireplace with an incredible advantage to you: YOU WON’T EVER NEED TO CHANGE THE WOOD!!

dolce vita

riscaldatori decorativi da esterno
decorative outdoor heaters

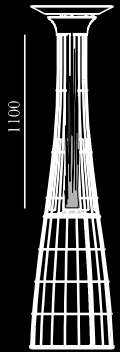

Dolce Vita con tavolino
Dolce Vita with coffee table

Dolce Vita E.P.
E.P. Dolce Vita
(electricity producing)



Dolce Vita con luci
Dolce Vita with lights





Falò, riscaldatore da esterno
Falò, *luxury patio heater*



Falò, riscaldatore da esterno
Falò, *luxury patio heater*



Falò, riscaldatore da esterno
Falò, *luxury patio heater*

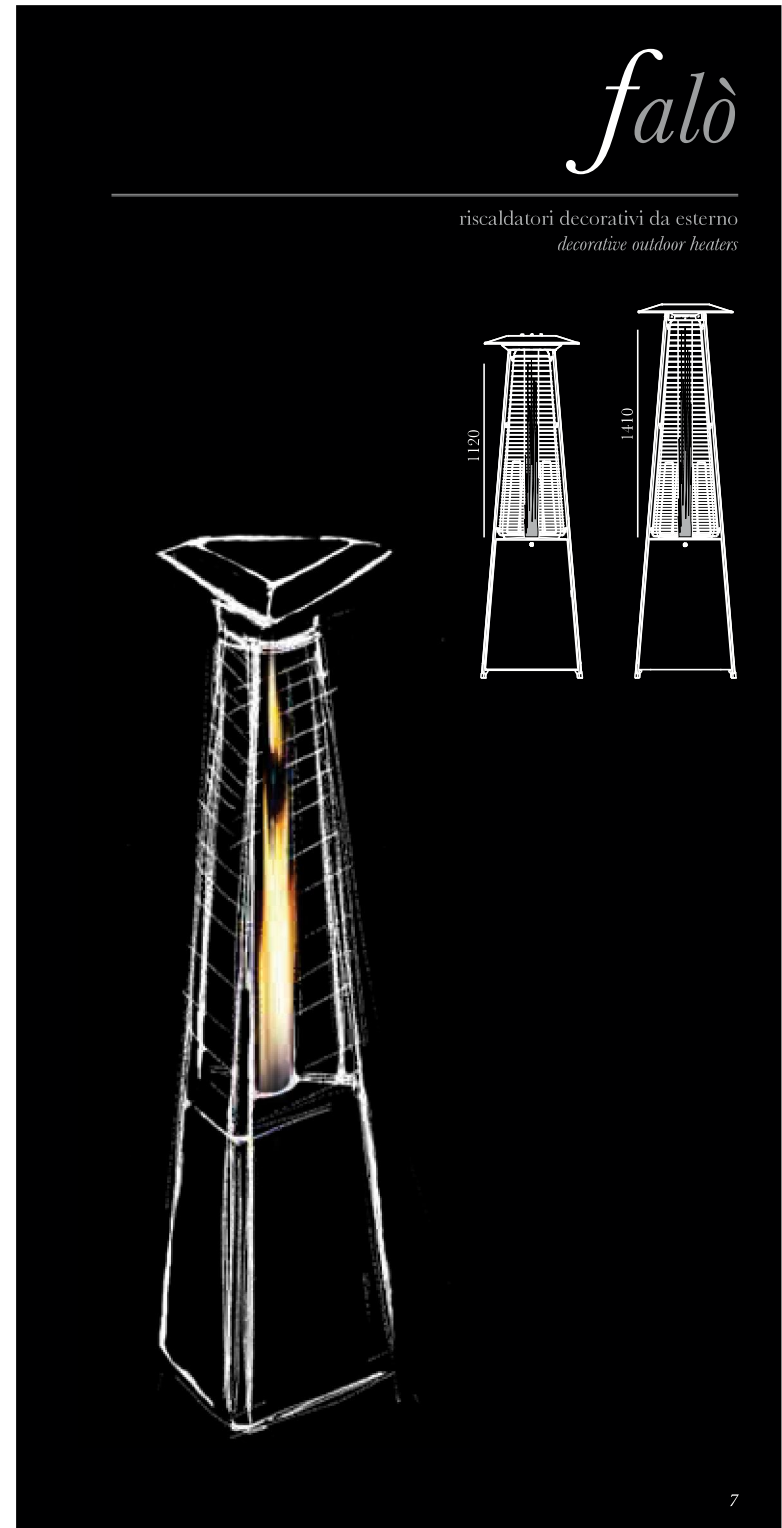



modello <i>model</i>	Dolce Vita comando manuale <i>manual control</i>	Dolce Vita comando infrarossi <i>remote control</i>	Dolce Vita E.P. (electricity producing) comando infrarossi <i>remote control</i>	Falò comando manuale <i>manual control</i>	Falò comando infrarossi <i>remote control</i>	Falò evo comando manuale <i>manual control</i>	Falò evo comando infrarossi <i>remote control</i>
codice GPL <i>code LPG</i>	LF12M2 L0000	LF12A2 L0000	LF12A2 LG000	FL12M0 L0100	FL12A0 L0100	FL12ME L0100	FL12AE L0100
codice Metano <i>code Methane</i>	LF12M2 M0000	LF12A2 M0000	LF12A2 MG000	FL12M0 M0100	FL12A0 M0100	FL12ME M0100	FL12AE M0100
struttura <i>structure</i>	INOX brillantato stainless STEEL	INOX brillantato stainless STEEL	INOX brillantato stainless STEEL	ALLUMINIO + verniciatura ALUMINUM + trasparent painted	ALLUMINIO + verniciatura ALUMINUM + trasparent painted	ALLUMINIO + verniciatura ALUMINUM + trasparent painted	ALLUMINIO + verniciatura ALUMINUM + trasparent painted
vista fiamma h (cm) <i>flame view h</i>	110	110	110	141	141	112	112
portata (kW) <i>heat input</i>	12	12	12	12	12	12	12
alimentazione (V) <i>power supply</i>	nr. 1 x 1,5 (tipo AA)	nr. 2 x 1,5 (tipo torcia D)	nr. 2 x 1,5 (tipo torcia D)	nr. 1 x 1,5 (tipo AA)	nr. 2 x 1,5 (tipo torcia D)	nr. 1 x 1,5 (tipo AA)	nr. 2 x 1,5 (tipo torcia D)
alimentazione luci LED (V) <i>LED lights power supply</i>	12	12					
peso netto (Kg) <i>net weight</i>	27	28	31	29	30	28	29
peso lordo (Kg) <i>gross weight</i>	40,5	41,5	44,5	41,5	42	40,5	41



modello <i>model</i>	Torcia 90 (in rilievo / freestanding) comando infrarossi <i>remote control</i>	Torcia 90 (inserto / built in) comando infrarossi <i>remote control</i>	Spider (appeso / ceiling) comando infrarossi <i>remote control</i>
codice GPL <i>code LPG</i>	TN90A0 L0000	TN90A0 L1000	RE07AS L0000
codice Metano <i>code Methane</i>	TN90A0 M0000	TN90A0 M1000	RE07AS M0000
copertura <i>cover</i>	ALLUMINIO + verniciatura ALUMINUM + trasparent painted		
vista fiamma h (cm) <i>flame view h</i>	50	50	
portata (kW) <i>heat input</i>	3	3	7,5
alimentazione (V) <i>power supply</i>	nr. 2 x 1,5 (tipo torcia D)	nr. 2 x 1,5 (tipo torcia D)	nr. 2 x 1,5 (tipo torcia D)
alimentazione luci LED (V) <i>LED lights power supply</i>	12		
peso netto (Kg) <i>net weight</i>	7	8	9
peso lordo (Kg) <i>gross weight</i>	8	9	10,3

Accessori • Accessories *DolceVita, Falò, Spider*



Telecomando.

Remote control.

code model
70001552 00 DolceVita, Falò, Spider.



Tavolino Caffè (diametro 80cm).

Coffee table (external diameter Ø 80cm).

code model
70001571 00 DolceVita.



KIT Luci LED SENSOR (attivazione a sfioramento del sensore): luci LED, batteria, kit di ricarica, supporto batteria.

NOTA: non installabile su modello E.P.

Sensor LED lighting kit: led lights, rechargeable battery, recharge kit and battery support.

NOTE: not for E.P. model.

code model
70001561 00 DolceVita, Torcia.



Batteria addizionale.

NOTA: non installabile su modello E.P.

Additional rechargeable battery.

NOTE: not for E.P. model.

code model
70001562 00 DolceVita.

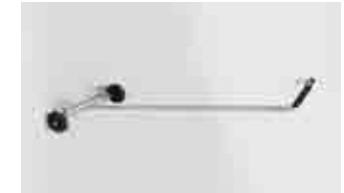

Trolley addizionale per il trasporto.

Additional trolley.

code model
70004566 00 DolceVita.



Cappello grande (diametro esterno Ø75cm).

Larger hat (external diameter Ø 75cm).

code model
70001581 00 DolceVita.



Piano di appoggio su misura.
NOTA: contattare l'Uff. Commerciale per definire
- forma desiderata
- dimensione
- tipo di materiale (vetro, legno, ecc.)
- costo e tempi di consegna.

Support plane.
NOTE: contact the Sales office to define
- desired shape
- size
- type of material (glass, wood, etc.)
- cost and delivery times.

code model
000015 DolceVita.



Ruote per trasporto.

Wheels.

code model
70004565 00 Falò.



Colorazione dei tre montanti della struttura.
NOTA: specificare il colore RAL desiderato.

Painting of three poles of the structure.
NOTE: specify the requested RAL color code.

code model
000008 Falò.



Kit alimentazione elettrica (3V-35mA), per non sostituire le pile nell'unità ricevente.

Power supply kit (3V - 35mA).

code model
70004540 00 Spider.

dimensioni • dimensions

DolceVita comando MANUALE DolceVita MANUAL control



Dotazioni:

- trolley per il trasporto
- dispositivo di sicurezza antiribaltamento con blocco automatico alimentazione gas
- struttura in acciaio INOX brillantato
- comando manuale, vari livelli di potenza

Equipped:

- trolley
- anti-tipping device
- polished stainless steel structure
- manual control, various power levels

DolceVita comando INFRAROSSI DolceVita REMOTE control



Dotazioni:

- trolley per il trasporto
- dispositivo di sicurezza antiribaltamento con blocco automatico alimentazione gas
- struttura in acciaio INOX brillantato
- centralina comando con ricevitore, 3 livelli di potenza

Equipped:

- trolley
- anti-tipping device
- polished stainless steel structure
- remote control, 3 power levels

DolceVita E.P. comando INFRAROSSI (electricity producing) E.P. DolceVita with REMOTE control (electricity producing)



electricity producing



batteria / battery

Dotazioni:

- trolley per il trasporto
- dispositivo di sicurezza antiribaltamento con blocco automatico alimentazione gas
- struttura in acciaio INOX brillantato
- centralina comando con ricevitore, 3 livelli di potenza
- luci LED SENSOR (attivazione con sfioramento del sensore) per illuminazione base

Equipped:

- trolley
- anti-tipping device
- polished stainless steel structure
- remote control, 3 power levels
- sensor LED lighting kit

Dolce Vita - manuale • manual
LF12M2 M0000
LF12M2 L0000

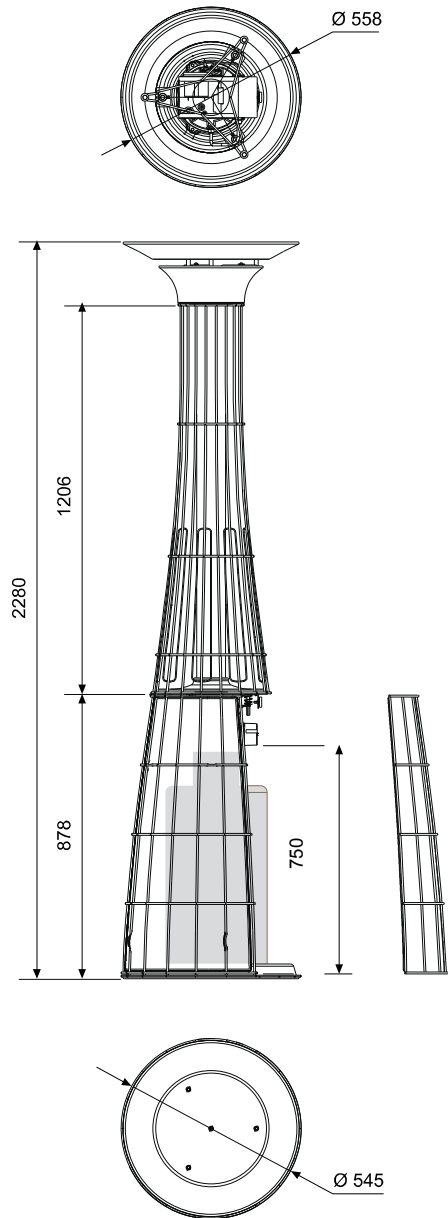

Dolce Vita - infrarossi • remote control
LF12A2 M0000
LF12A2 L0000

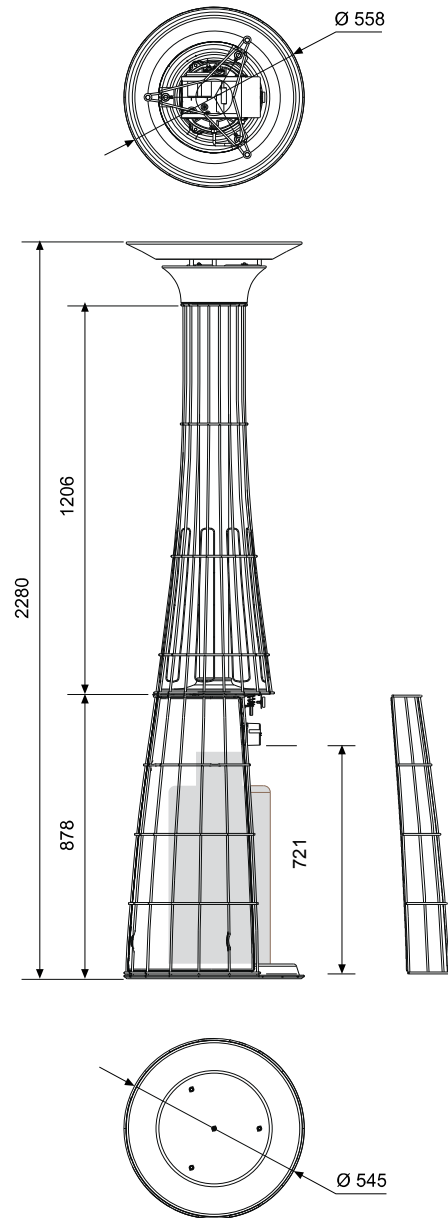

Dolce Vita E.P. - infrarossi • remote control
LF12A2 MG000
LF12A2 LG000

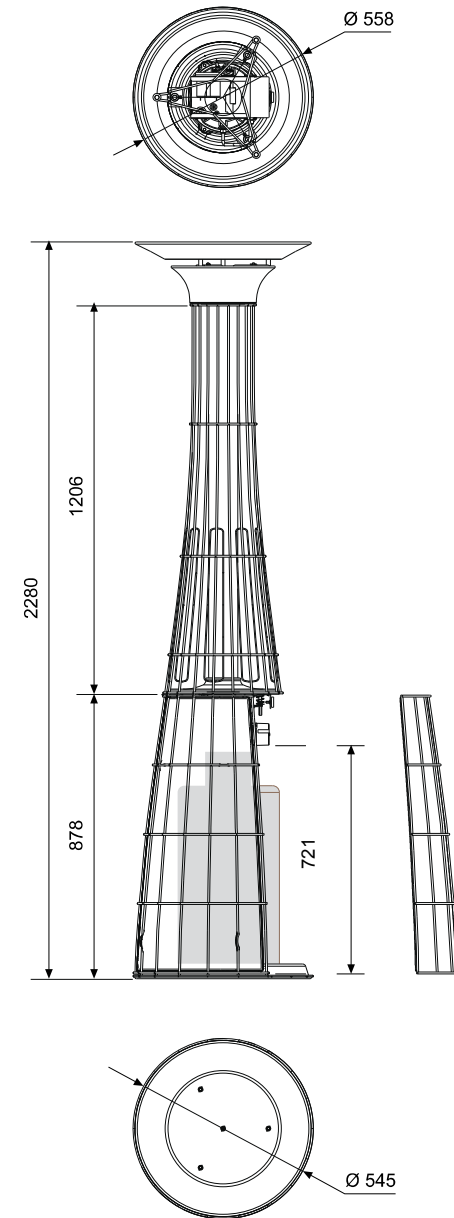

Falò comando MANUALE
Falò MANUAL control

Dotazioni:

- dispositivo di sicurezza antiribaltamento con blocco automatico alimentazione gas
- piedini in gomma antigraffio
- comando manuale, vari livelli di potenza

Equipped:

- anti-tipping device
- rubber feet
- manual control, various power levels



Falò - manuale • manual
FL12M0 M0100
FL12M0 L0100

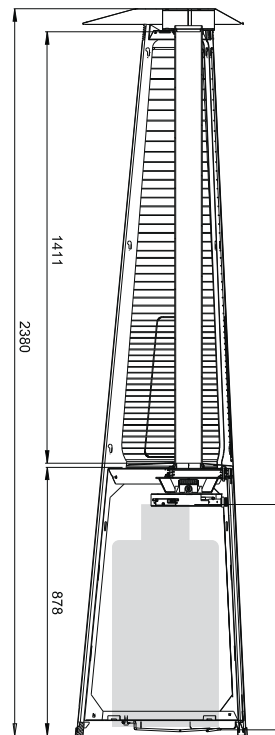
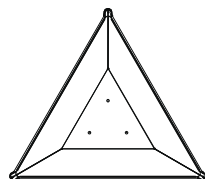
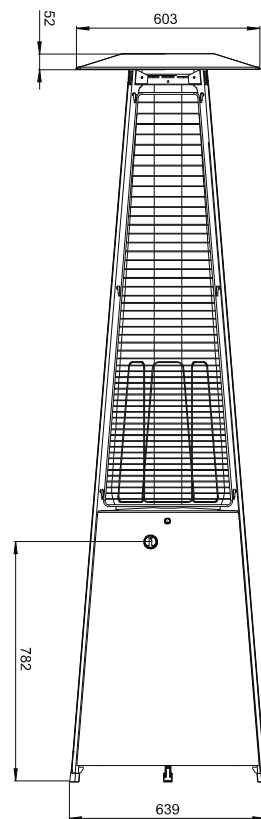

Falò - infrarossi • remote control
FL12A0 M0100
FL12A0 L0100

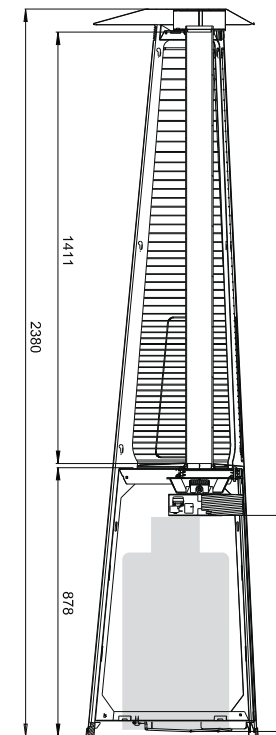
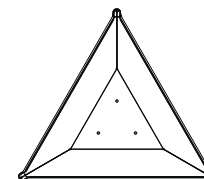
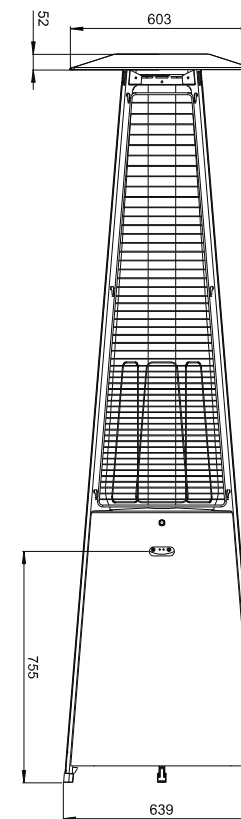

Falò comando INFRAROSSI
Falò REMOTE control



Dotazioni:

- dispositivo di sicurezza antiribaltamento con blocco automatico alimentazione gas
- piedini in gomma antigraffio
- centralina comando con ricevitore, 3 livelli di potenza

Equipped:

- anti-tipping device
- rubber feet
- remote control, 3 power levels



Falò evo comando MANUALE

Falò evo MANUAL control

Dotazioni:

- dispositivo di sicurezza antiribaltamento con blocco automatico alimentazione gas
- piedini in gomma antigraffio
- comando manuale, vari livelli di potenza

Equipped:

- anti-tipping device
- rubber feet
- manual control, various power levels



Falò evo - manuale • manual

FL12ME M0100

FL12ME L0100

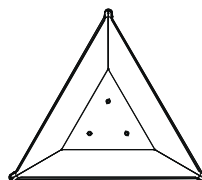
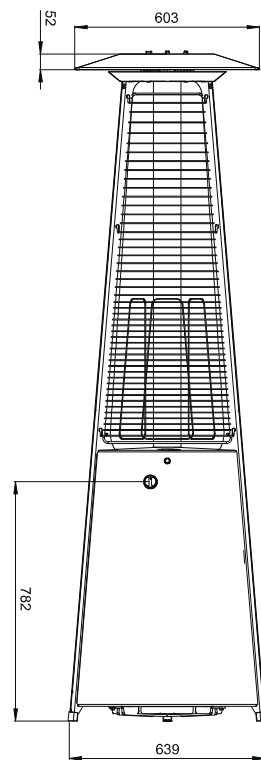

Falò evo - infrarossi • remote control

FL12AE M0100

FL12AE L0100

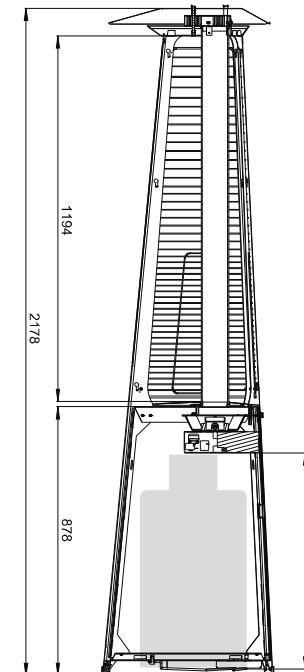
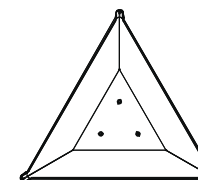
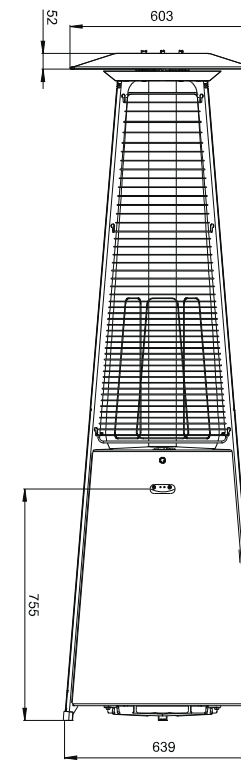

Falò evo comando INFRAROSSI

Falò evo REMOTE control



Dotazioni:

- dispositivo di sicurezza antiribaltamento con blocco automatico alimentazione gas
- piedini in gomma antigraffio
- centralina comando con ricevitore, 3 livelli di potenza

Equipped:

- anti-tipping device
- rubber feet
- remote control, 3 power levels





Italkero s.r.l. Via Lumumba, 2 - 41122 Modena | T. +39 059 2550711 | F. +39 059 4900500 | info@italkero.it | www.italkero.it | www.italkero.com

NOTA: Nel continuo perfezionamento del prodotto, le caratteristiche tecniche e dimensionali, i dati tecnici, gli equipaggiamenti e gli accessori, possono essere soggetti a variazione.
 NOTE: Due to ongoing product upgrading, aesthetic and dimensional features, technical details, fittings and accessories could undergo changes and are not binding.